

HP **1500**

Instructions for use
English 4

Mode d'emploi
Français 30

Bedienungsanleitung
Deutsch 56

Gebruiksaanwijzing
Nederlands 82

Instrucciones de manejo
Español 108

Manual de utilização
Português 134

Istruzioni per l'uso
Italiano 160

Bruksanvisning
Svenska 186



PHILIPS

FIGURE 1

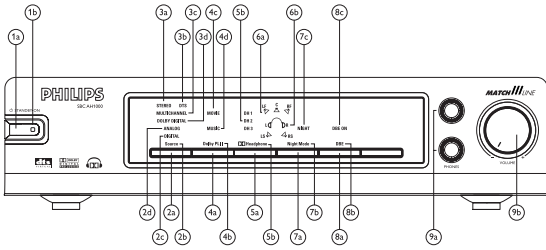

FIGURE 2

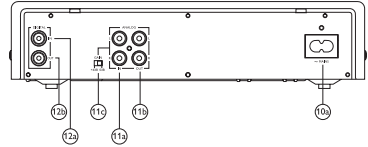

FIGURE 3

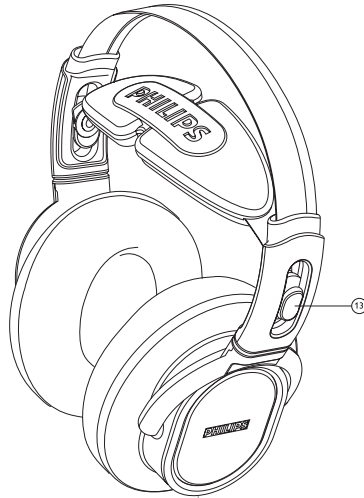

FIGURE 4

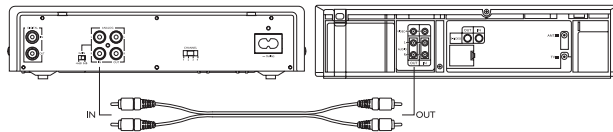
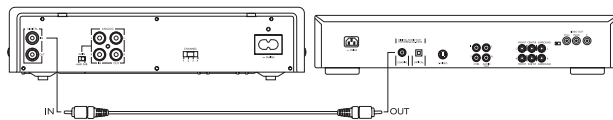

FIGURE 5



 **Helpline (www.p4c.philips.com)****België/Belgien/Belgique**

32-2-525.81.11

Nederland

0900-8406

Danmark

45 33 29 33 33

Norge

47-22-748 000

Deutschland

49-40-28990

Österreich

43-1-601 01

España

34-91-4042200

Portugal

+351-21-416 33 33

France

33 1 47 28 10 00

Schweiz/ Suisse/ Svizzera

41-1-48 82 211

Ελλάνας

30-1-4894911

Suomi

358-9-615 800

Ireland

353-1-764 0000

Sverige

468 598 520 00

Italia

39.039.203.1

UK (United Kingdom)

44-208-689 2166

***'Dolby', 'Pro Logic' and the double-D symbol
are trademarks of Dolby Laboratories.***

***'DTS' and 'DTS Virtual' are trademarks of
Digital Theater Systems, Inc.***

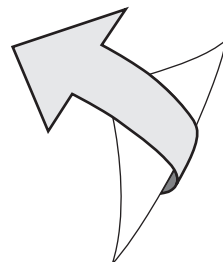

4 ENGLISH

Index

4	Introduction
5	System configuration
6	Dolby Headphone
7	Advanced technologies used in HP 1500
10	Digital audio formats
10	Important information
11	Benefits of latest sound processing technology
11	Kit contents
12	Functional overview
15	Installation
15	Audio connections
26	Basic operation
27	Problem solving
28	Maintenance
28	Technical specifications
29	European Regulations

Introduction

SBC HP1500

Congratulations! You have just bought a most sophisticated digital headphone system.

This system uses state of the art digital technology, offering you the freedom of enjoying your favourite music or movies in the purest digital quality. Even silent passages in classical music and plain silence in between two music tracks are reproduced as pure silence.

This system has been designed to faithfully reproduce the kind of multi-channel surround sound experience that you normally can enjoy with a conventional multi-channel speaker set-up. The latest digital signal processing technology is being used to ensure that you can indulge yourself in an overwhelming private home entertainment experience. And all this at the volume level that you personally prefer without running the risk of disturbing the neighbours or the family!

To ensure you get the best performance from your digital headphone system please read this manual carefully.

System configuration

The HP 1500 system consists of a digital base station and a pure Hifi headphone. The base station contains a digital signal processor offering you a real 5.1-channel surround sound experience through the personal comfort of your headphone.

The base station can decode Dolby Pro Logic II signals as well as Dolby Digital and DTS signals. The Dolby Headphone technology will ensure that these signals are converted to audio signals that can be handled by the headphone whilst still maintaining the directional information as in the original signals.

The base station has an analogue stereo input as well as a digital electrical coaxial S/PDIF input. The digital input allows you to enjoy your favourite DVD movies in full surround sound through Dolby Pro Logic II, Dolby Digital or DTS. And the analogue input brings your collection of VCR tapes back to life in full Dolby Pro Logic II surround sound.

The pure Hifi headphone that comes with the HP1500 system will provide you with pure audio quality that is second to none.

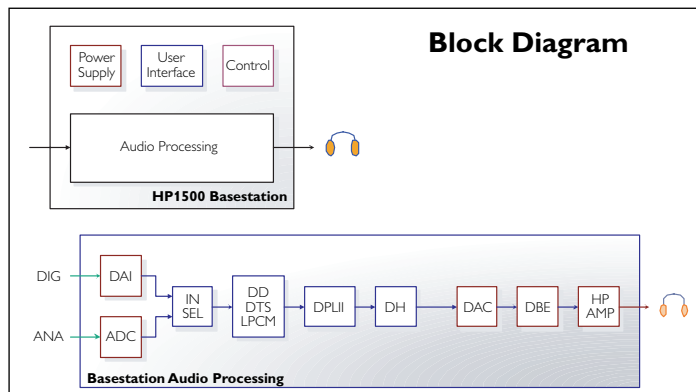

Dolby Headphone

A brief introduction

Dolby Digital and DTS provide discrete left and right surround channels, for more precise localization of sound and a more convincing, realistic ambience. Discrete means that each channel contains its own particular audio information and plays a unique role in creating a realistic surround sound experience.

Up until now all this was reserved to speaker set-ups, but thanks to Dolby Headphone, the ultimate experience in home theatre surround with five (left, right, centre, rear-left and rear-right) discrete channels of digital sound quality is now also available to headphones.

Dolby Headphone is a revolutionary signal processing system that works not only with multi channel audio but also with conventional stereo signals. In case of multi channel audio signals, Dolby Headphone technology will process these signals in such a way that you will experience the sound through your headphone as if it were coming from an actual five speaker home entertainment set-up. And even when listening to conventional stereo signals, Dolby Headphone will give you a much more natural and less fatiguing listening experience, equivalent to a good two-speaker playback system in a room with good acoustics.

Dolby Headphone technology can model the sound of a playback system in up to three different listening environments, based on acoustic measurements of real rooms:

- **DH1** is a small, well-damped room appropriate for both movies and music-only recordings.
- **DH2** is a more acoustically live room particularly suited to music listening, but also great for movies.
- **DH3** is a larger room, more like a concert hall or movie theatre.

You can easily switch between these room modes and select whichever one suits the particular program material and your own preferences.

Advanced technologies used in HP 1500

The HP1500 makes use of several advanced technologies.

Principle of determining the direction of sound

People can determine the localization of sounds through the perception of differences in intensity – so called Interaural Intensity Difference (IID) – and through time differences – so called Interaural Time Difference (ITD).

IID is about the fact of sounds being louder as they are closer to the ear and being louder in case they have a non-obstructed path to the ear:

ITD is about the fact that in most cases sounds will arrive earlier in time at one ear than at the other:

In fact it is the environment itself that greatly impacts the sound before it reaches our ears. Reflections and absorption all will influence the sense of distance and direction we associate with a sound.

Combining IID and ITD will allow the brain to determine the direction of sounds only in a rough way. It is in through the combination of IID and ITD and the way sounds are filtered because of the structure of the pinna – the outer ear – that allows to brain to accurately localise sounds.

- Depending on how a sound wave hits the pinna, it will be emphasized or suppressed.
- Depending on how a sound wave hits the pinna, reflections within the pinna are created, altering the phase relationship within the spectrum of the sound wave.
- And also: higher frequencies are more affected by the pinna than lower frequencies. That's why our brain can easily locate higher frequencies, rather than lower frequencies.

8 ENGLISH

If we wish to reproduce all those effects through an audio system, than we need to take IID, ITD, pinna effects, room impulse response, etc. into account. That is where Head-Related Transfer Functions (HRTF) come into play.

An HRTF is a mathematical equation that describes how a sound is effected when travelling from its source to our ears.

There are several ways to synthesise an HRTF. The most common way to measure an HRTF makes use of placing tiny microphones in a listener's ears.

Every person has its unique HRTF. However, we can identify crucial parts in an HRTF that are responsible for localization of sound as if this sound would be radiated by a typical home cinema speaker set-up. When these parts are synthesized in an optimal way, a typical 5 speaker set-up listening experience is created.

HRTFs are implemented in real-time Digital Signal Processors (DSP) and will then be applied to audio signals in order to reproduce "spatial" cues, i.e. create a sense of directionality.

It is through these techniques that Philips is able to bring you a home cinema experience through a headphone that is as real as when you would be listening to an actual 5.1 speaker set-up.

Automatic Audio Signal Routing

The Automatic Audio Signal Routing (AASR) feature of the HP 1500 basestation allows for audio sources to be connected to its audio inputs and at the same time it can pass those same audio signals on to – for example – your Home Cinema receiver. This allows for permanent audio connections to be made without the need for swapping cables. Whether you want to listen to your headphone or your existing speaker set-up, it no longer involves tiresome swapping of cables: the choice is yours at the flick of a switch.

Intelligent user interface

After a digital analysis of the audio input signal the display will indicate which sound processing features can be activated. No more frustrating pressing of all buttons. Just read the display and select out of the active sound menus.

Headphone construction

The headphone's semi-open construction will benefit the transparency of the sound. This will make you experience your favourite tracks under even more realistic conditions.

Neodymium magnets

Neodymium is the strongest magnet material available, which optimises the behaviour of the speaker coil for increased sound pressure levels and a more powerful bass response. All this at the lowest possible levels of distortion.

10 ENGLISH

Digital audio formats

The device will recognize the following digital input signals:

- Stereo LPCM with sample frequencies 44.1 kHz and 48kHz
- Dolby® Digital (AC-3), up to 5.1 channels
- DTS®, up to 5.1 channels

In case an invalid digital signal is detected - for example a digital MP3 data stream - the 'DIGITAL' indication LED will be illuminated in red.

In case a valid digital signal is detected - for example a digital DTS data stream - the 'DIGITAL' indication LED will be illuminated in green.

***TO ENSURE YOU GET THE BEST PERFORMANCE FROM YOUR DIGITAL HEADPHONE SYSTEM:
PLEASE READ THIS MANUAL CAREFULLY.***

Important information

- Please read the following instructions carefully, and retain this booklet for future reference. All the safety and operating instructions should be read before using the digital headphone system.
- Check if the voltage indicated on the type plate (located at the bottom of the set) corresponds to the local mains voltage before connecting to the mains power supply.
- Remove the batteries from the headphone's battery compartment and from the base station's charging compartment and disconnect the power cable from the mains if the system is not in use for a long period.
- Prevent fire or shock hazard: do not expose this equipment to humidity, rain, sand or excessive heat caused by heating equipment or direct sunlight.

Safety precautions

- Do not use this product in damp places or close to water.
- Do not expose this product to extreme heat.
- Do not open this product.
In the event of technical difficulties take it to your Philips retailer.
- Do not cover this product.
- Inadequately protected or sensitive electronic equipment may be affected by the use of this product. This interference may lead to damage to either equipment. Please check whether or not surrounding equipment may be affected by this product before you start using it.

Benefits of latest digital sound processing technology

Dolby Digital and DTS

Dolby Digital and DTS allow you to listen to DVD movies or concerts in full surround sound.

Dolby Headphone

In case of multi channel audio signals, **Dolby Headphone technology** will make you hear the sound through your headphone as if it is coming from five speakers. In case of a stereo signal, Dolby Headphone will give you a much more natural and less fatiguing listening experience, equivalent to a good two-speaker playback system in a room with good acoustics.

Kit contents

This headphone system consists of the following accessories:

- 1 x SBC AH 1000 base station
- 1 x SBC HP 1000 pure Hifi headphone (incl. accessories)
- 1 x AC mains cable
- 1 x RCA stereo audio cable (2 m)
- 1 x coaxial S/PDIF digital audio cable (2 m)
- 1 x headphone stereo audio extension cable (4 m)

Functional overview - Product illustrations on inside flap

Base station front panel (figure 1)

1 Power section

- a) power on/standby and demo mode button
 - By holding the 'STANDBY-ON' button for 1,5 seconds or longer, the demo mode can be activated:
 - Pink noise is used to simulate the position of the 5 virtual speakers in the headphone.
 - The corresponding speaker indicator in the output section of the display will go on indicating which speaker is being simulated.
 - The demo mode can be deactivated by pressing any control button on the base station.
- b) STANDBY-ON' dual-color LED
 - Red = base station in standby mode
 - Green = base station in active mode

2 Source select section

- a) button to toggle between the analogue and digital coaxial inputs
- b) 'Source' menu yellow LED
- c) 'ANALOG' indication green LED
- d) 'DIGITAL' indication illuminated by dual colour LED:
 - Red = input signal is locked, but invalid (for instance 96 kHz) or unlocked (no signal)
 - Green = input signal is locked and valid (signal accepted)

3 The input signal detection section

- a) 'STEREO' indicator green LED (activated in case of detection of digital stereo signal or selection of analogue input source)
- b) 'DTS' indicator green LED (activated in case of detection of DTS signal)
- c) 'MULTICHANNEL' indicator green LED (activated in case of detection of multi-channel audio)
- d) 'DOLBY DIGITAL' indicator green LED (activated in case of detection of Dolby Digital signal)

4 Dolby Pro Logic II section

- a) button to activate Dolby Pro Logic II and to toggle between 'MUSIC' and 'MOVIE' mode.
- the preferred mode depends on the nature of the audio input signal:
 - In case of a digital audio signal: the preferred mode will automatically be selected first in case Dolby Pro Logic II is activated. By pressing the Dolby Pro Logic II button again the other (non-preferred) mode will be selected.
 - In case of an analogue audio signal: the mode, which was selected in previous listening sessions, will be activated first. By pressing the Dolby Pro Logic II button again the other mode will be selected.
- b) 'Dolby Pro Logic II' menu field yellow LED: lights up whenever Dolby Pro Logic II is possible (also when Dolby Pro Logic II is not selected but actually possible, the yellow LED will remain to be on)
- 'MOVIE' indicator green LED (in case of movie mode selection)
 - 'MUSIC' indicator green LED (in case of music mode selection)

5 Dolby Headphone (DH) section

- a) button to toggle between the three DH room modes and bypass mode
- b) 'Dolby Headphone' menu field yellow LED: lights up whenever DH is possible
- 'DH1' indicator green: Small Room mode
 - 'DH2' indicator green LED: Large Room mode
 - 'DH3' indicator green LED: Cinema mode
 - 'DH' LEDs off: bypass mode

6 Output display section

- a) 5 virtual multi-channel $\frac{5}{1}$, $\frac{5}{2}$, $\frac{5}{3}$, $\frac{5}{4}$ and $\frac{5}{RS}$ indicators green LEDs: light up whenever DH is activated
- b) Stereo $\frac{2}{1}$ indicator green LED: lights up whenever DH is de-activated and "ordinary" stereo is being reproduced

14 ENGLISH

7 Night mode section

- a) button to activate Night mode
 - Night mode will reduce the dynamics of the audio signal. This will result in both the loudest and the most silent audio signals becoming clearly audible, even at lower volume levels.
 - The audio signals on a DVD movie disc have large dynamics, i.e. the difference in loudness between the loudest and most silent signal can be very large. In order to hear both the loudest and most silent signal you normally would have to turn up to volume of the headphone. In case however you would prefer to listen at lower volume levels, it could result in the most silent signals becoming difficult to hear: by making use of the night mode this can be resolved.
- b) 'Night Mode' menu field yellow LED:
 - lights up whenever Night mode is possible
- c) 'NIGHT' indicator green LED:
 - lights up whenever Night mode is activated

8 Dynamic Bass Boost section

- a) button to toggle the DBB function
- b) 'DBB' menu field illuminated by yellow LED
- c) 'DBB' indicator green LED: lights up whenever DBB is active

9 Headphone output section

- a) 2 x 6.3mm headphone jack sockets
- b) rotary volume control

Base station rear panel (figure 2)

10 Power connector

- a) AC connector for AC mains cable

11 Analogue Input/Output connectors

- a) stereo input (L/R)
- b) stereo output (L/R) providing AASR function
- c) 2-position slide-switch to select the analogue input-GAIN (+6dB/0dB):
 - set to +6dB in case of weak audio input signals
 - set to 0 dB in case of distorted audio input signals

12 Digital Input/Output connectors

- a) coax input (S/P DIF)
- b) coax output (S/P DIF) providing AASR function

Headphone (figure 3)

13 Flexifit™ headband

- a) adjust the comfort level of the inner headband to your personal preference by simply pushing the adjustment button.

Installation

Base station power supply

- 1 Make sure the base station's rated voltage corresponds to the mains socket voltage.
- 2 Connect the AC mains cable to the AC mains socket at the rear of the base station.
Always disconnect the mains cable if the base station is not to be used for a long period of time.
- 3 In order to disconnect the basestation from the AC mains power, the AC mains cable needs to be unplugged from the AC mains power wall socket. The AC mains power wall socket should be easily accessible in normal operating conditions.

Audio connections

OPTION 1: ANALOGUE STEREO SOURCE:

Connecting the digital base station to an analogue stereo source (stereo TV, stereo VCR, (S)VCD player, tape recorder, etc.)

Base station

- 1 Connect one side of the RCA stereo audio cable (included) to the line output of the audio source and the other side to the analogue input of the base station.
Make sure the red RCA plug (right channel) is connected to the red connector (right channel) of the audio source.
The white RCA plug (left channel) must be connected to the white connector (left channel) of the audio source.
- 2 Next take the RCA cable that most likely came supplied with your analogue audio source. Connect one side of this second RCA stereo audio cable (not included) to the line input of your amplifier or home cinema receiver and the other side to the analogue output of the base station.

16 ENGLISH

When connecting your audio equipment in this way, you will be able to benefit from the Automatic Audio Signal Routing (AASR) feature. As long as the base station is powered – even in stand-by mode – the audio signal from the audio source will be made available not only to the digital base station but it will be routed through to the rest of your home entertainment set-up. Without the need for swapping cables you can decide whether you wish to enjoy the audio through your headphones or through for example the speakers of your home entertainment system.

3 Check if the red RCA plug (right channel) is connected to the right channel (red) of the audio source.

The white RCA plug (left channel) must be connected to the white connector (left channel) of the audio source.

4 Power on your audio source: switch on your audio source, i.e. stereo TV, stereo VCR, (S)VCD player, tape recorder, etc.

5 Output adjustment of your audio source: in case the line output of your audio source has an adjustable output level, adjust the line output level of the audio source to the highest acceptable undistorted level.

Note: In case of certain TVs, the line output level can only be adjusted through the TV's on screen menu.

6 Power on the base station: switch on the digital base station.

The power indication LED of the base station will change from red to green.

7 Sensitivity switch: if your audio source's output signal is relatively weak, the sensitivity switch at the back of the digital base station should be changed from 0dB to +6dB. This will provide the necessary additional amplification to the audio input signal prior to processing.
If this results in a distorted signal, then set the switch back to 0dB.

8 Source select: select the analogue input on the base station by pressing the 'Source' button.

9 Input signal detection: once a stereo audio signal is detected the input signal indicator 'STEREO' will be illuminated.

Note: In case of multilingual NICAM transmissions, you should select the appropriate language in your TV's menu. In that case the audio signal will no longer be stereo but only mono and the effect of for example Dolby Pro Logic II or Dolby Headphone will very be limited.

- 10 Dolby Pro Logic II:** the 'Dolby Pro Logic II' menu field indicator will be illuminated in yellow indicating that Dolby Pro Logic II is possible.

Press the Dolby Pro Logic II button to activate Dolby Pro Logic II.

Pressing this button repeatedly will allow you to toggle between 'MUSIC' and 'MOVIE' mode and bypass mode (= MUSIC and MOVIE LED are both off). In case of an analogue audio signal: the mode, which was selected in previous listening sessions, will be activated first. By pressing the Dolby Pro Logic II button again the other mode will be selected.

- 11 Dolby Headphone:** Dolby Headphone will automatically be activated as soon as Dolby Pro Logic II is activated. Pressing the 'Dolby Headphone' button repeatedly will allow you to toggle between the different DH rooms and the by-pass mode (= DH1, DH2, DH3 are both off).

By-passing Dolby Headphone processing will also de-activate Dolby Pro Logic II.

The following table will illustrate the different combinations of Dolby Pro Logic II and Dolby Headphone and the resulting indication in the display of the base station.

ANALOG STEREO AUDIO INPUT		
	Dolby Headphone on	Dolby Headphone off
Dolby Pro Logic II on		Dolby Pro Logic II will automatically be switched off
Dolby Pro Logic II off		

For example:

- when DPL II is on (in Music or Movie mode) Dolby Headphone will automatically be activated: all green virtual multi-channel indicators (LF, C, RF, LS, RS) will light up;
- when DPLII is off but Dolby Headphone is still activated, the green LF RF indicator lights up, indicating Dolby Headphone stereo sound reproduction;
- when Dolby Headphone is bypassed (resulting in Dolby Pro Logic II automatically being bypassed too), the green stereo L R indicator lights up, indicating normal stereo sound reproduction.

18 ENGLISH

- 12 Night mode:** this option is not available in case of analogue audio signals. The 'Night Mode' menu field indicator is off: NIGHT mode cannot be activated.
- 13 DBB:** the Dynamic Bass Boost function is only applicable to headphones connected to the 6.3 mm headphone outputs.
- 14 Volume control:** the Volume control function is only applicable to headphones connected to the 6.3 mm headphone outputs.

Headphone

- 1 HP1000 headphone jack:** connect the headphone jack to one of the headphone outputs on the base station.
You can connect up to 2 headphones simultaneously.
- 2 Headphone stereo audio extension cable (4 m):** you can connect the extension cable in between one of the base station's headphone outputs and the HP1000 headphone.
- 3 Flexifit™ headband:** adjust the comfort level of the inner headband to your personal preference by simply pushing the adjustment button.

OPTION 2: DIGITAL STEREO OR MULTI CHANNEL SOURCE:

Connecting the digital base station to a digital stereo source (CD player with S/PDIF output, etc.) or a digital multichannel source (DVD player with S/PDIF output, etc.)

Base station

- 1** Connect one side of the S/PDIF digital audio cable (included) to the S/PDIF output of the audio source and the other side to the S/PDIF input of the base station.
- 2** Next take the S/PDIF cable that most likely came supplied with your digital audio source. Connect one side of this 2nd S/PDIF digital audio cable (not included) to the S/PDIF input of your amplifier or home cinema receiver and the other side to the S/PDIF output of the base station.

When connecting your audio equipment in this way, you will be able to benefit from the Automatic Audio Signal Routing (AASR) feature. As long as the base station is powered – even in stand-by mode – the audio signal from the audio source will be made available not only to the digital base station but it will be routed through to the rest of your home entertainment set-up. Without the need for swapping cables you can decide whether you wish to enjoy the audio through your headphones or through for example the speakers of your home entertainment system.

- 3** Check if the red RCA plug (right channel) is connected to the right channel (red) of the audio source.
- 4** Power on your audio source: switch on your audio source, i.e. DVD player with S/PDIF output, CD player with S/PDIF output, etc.

IMPORTANT!

- **In case of connecting an audio CD player to the HP1500 base station making use of the CD player's digital outputs: do not up sample the Audio CD digital output signal higher than 44.1 kHz.**
- **When connecting a DVD player to the HP1500 base station: do not up sample the DVD digital output signal higher than 48 kHz.**

5 Power on the base station: switch on the digital base station.

The power indication LED of the base station will change from red to green.

6 Source select: select the digital input on the base station by pressing the 'Source' button.

The digital indicator will light up in GREEN. In case of an invalid digital signal (for example a digital MP3 data stream) the digital indicator will be RED blinking.

The device will recognize the following digital input signals:

- Stereo LPCM with sample frequencies 44.1 kHz and 48kHz
- Dolby® Digital (AC-3), up to 5.1 channels
- DTS®, up to 5.1 channels

7 Input signal detection: after the input signal has been analyzed, its nature will automatically be indicated on the display of the base station.

- Stereo: will light up in case of a digital stereo signal
(for example when playing a CD in a CD/DVD player;
or when playing a VCD in a DVD player)
- Multichannel: will light up in case of a digital multichannel signal
(for example when playing a DVD in a DVD player.
The following multichannel streams can be decoded:
- DTS: the DTS indicator will light up in GREEN.
- Dolby Digital: the Dolby Digital indicator will light up in GREEN

8 Dolby Pro Logic II: the 'Dolby Pro Logic II' menu field indicator will be illuminated in yellow in case of a digital stereo signal.

In case of a digital multichannel signal, Dolby Pro Logic II will not be illuminated (since it is not a valid option for such signals).

Press the Dolby Pro Logic II button to activate Dolby Pro Logic II. Pressing this button repeatedly will allow you to toggle between 'MUSIC' and 'MOVIE' mode and bypass mode (= MUSIC and MOVIE LED are both off). In case of an digital stereo audio signal: the mode, which was selected in previous listening sessions, will be activated first. By pressing the Dolby Pro Logic II button again the other mode will be selected.





9 Dolby Digital or DTS: in case of digital multichannel signals, the base station will automatically detect whether the signal is Dolby Digital encoded or DTS encoded. In any of these cases Dolby Headphone will be activated automatically.

10 Dolby Headphone: Pressing the 'Dolby Headphone' button repeatedly will allow you to toggle between the different DH rooms and the by-pass mode (= DH1, DH2, DH3 are both off).

By-passing Dolby Headphone processing is not possible in case of multichannel Digital audio signals.

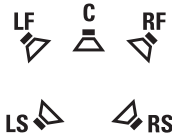

22 ENGLISH

The following tables will illustrate the different combinations of Dolby Pro Logic II, Dolby Digital, DTS and Dolby Headphone and the resulting indication in the display of the base station depending on the nature of the digital audio input signal (i.e. stereo or multichannel).

DIGITAL STEREO AUDIO INPUT		
	Dolby Headphone on	Dolby Headphone off
Dolby Pro Logic II on		Dolby Pro Logic II will automatically be switched off 
Dolby Pro Logic II off		

For example:

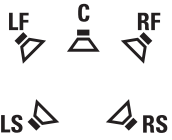
- when Dolby Pro Logic II is on (in Music or Movie mode) Dolby Headphone will automatically be activated: all green virtual multi-channel indicators (LF, C, RF, LS, RS) will light up;
- when Dolby Pro Logic II is off but Dolby Headphone is still activated, the green LF, RF indicator lights up, indicating Dolby Headphone stereo sound reproduction;
- when Dolby Headphone is bypassed (resulting in Dolby Pro Logic II automatically being bypassed too), the green stereo LD, DR indicator lights up, indicating normal stereo sound reproduction.

DIGITAL MULTICHANNEL AUDIO INPUT		
	Dolby Headphone on	Dolby Headphone off
Dolby Digital on		Impossible
DTS on		Impossible

For example:

- when Dolby Digital is on then Dolby Headphone will automatically be activated: all green virtual multi-channel indicators (LF, C, RF, LS, RS) will light up;
- switching off Dolby Headphone in case of a Dolby Digital multichannel signal is not possible.
- similar for DTS multichannel signals.

- 11 Night mode:** this option is only available in case of digital stereo or digital multichannel audio signals. When the 'Night Mode' menu field indicator is on, 'NIGHT' mode can be activated.
- 12 DBB:** the Dynamic Bass Boost function is only applicable to headphones connected to the 6.3 mm headphone outputs.
- 13 Volume control:** the Volume control function is only applicable to headphones connected to the 6.3 mm headphone outputs.

Headphone

- 1 HP1000 headphone jack:** connect the headphone jack to one of the headphone outputs on the base station.
You can connect up to 2 headphones simultaneously.
- 2 Headphone stereo audio extension cable (4 m):** you can connect the extension cable in between one of the base station's headphone outputs and the HP1000 headphone.
- 3 Flexifit™ headband:** adjust the comfort level of the inner headband to your personal preference by simply pushing the adjustment button.

OPTION 3: SACD PLAYER:

Connecting the digital transmitter to a Philips SACD player

Philips SACD players come with a multitude of audio output connectors. Some of the Philips SACD players can even function as a DVD video player.

The following will explain the different possibilities of connecting your Philips SACD player to the HP1500 base station.

Using the electrical coaxial digital S/PDIF output of your SACD player

- 1 Connect to the HP1500 base station's digital S/PDIF input.
 - Follow instructions as per OPTION 2.
 - This option only allows you to listen to audio CDs (not Super Audio CDs) through your HP1500 base station.

IMPORTANT!

- **When playing Super Audio CDs you should not use the digital electrical S/PDIF output of your SACD player when connecting it to the HP1500 base station.**
- **The digital electrical S/PDIF output will ONLY be able to output audio CD signals and not Super Audio CD signals.**
- **As per the SACD standard SACD audio is not available on digital electrical S/PDIF output.**

- 2 Using the analogue 5.1 output of your SACD player:
 - In case you wish to make use of the analogue audio outputs of your SACD player when connecting your SACD player to your HP1500 base station, we recommend you select the "stereo" mode or "Dolby Pro Logic" mode through your SACD player's menu.
 - For more details on the different menu options of your SACD player: please refer to its instruction manual.

3 Upsampling:

- Some SACD players allow for audio CDs to be upsampled from 44.1 kHz/16 bit to various higher sampling rates.
- When connecting your SACD player to the HP1500 base station through the digital coaxial S/PDIF connector, you should not upsample the audio signal.
- The HP1500 base station will recognize the following digital input signals:
 - Stereo LPCM with sample frequencies 44.1 kHz and 48kHz
 - Dolby® Digital (AC-3), up to 5.1 channels
 - DTS®, up to 5.1 channels

IMPORTANT!

- ***In case of connecting a Super Audio CD player to the HP1500 base station making use of the SACD player's digital outputs: do not upsample the Super Audio CD digital output signal higher than 44.1 kHz.***
- ***When connecting a DVD player to the HP1500 base station: do not upsample the DVD digital output signal higher than 48 kHz.***

In case an invalid digital signal is detected - for example a digital MP3 data stream - the 'DIGITAL' indication LED in the HP1500 display window will be illuminated in red. In case a valid digital signal is detected - for example a digital DTS data stream - the 'DIGITAL' indication LED will be illuminated in green.

Basic operation

When the base station is connected to a:

- **analogue line output of an analogue stereo source (stereo TV, stereo VCR, (S)VCD player, tape recorder, etc.)**
- **digital electrical coaxial S/PDIF output of a stereo source (CD player with S/PDIF output, etc.) or a multichannel source (DVD player with S/PDIF output, etc.)**

- 1** Switch on your audio source.
- 2** Switch on the HP1500 base station: the power indicator will change from red to green.
- 3** Select the input source you wish to listen to (analogue or digital):
 - In case of analogue input source: you can select Dolby Prologic II; activation of Dolby Headphone is optional.
 - In case of digital input source: Dolby Digital or DTS will be activated automatically, together with Dolby Headphone.
- 4** In case you activate Dolby Headphone you can toggle between the 3 modes and bypass mode.
- 5** In case you want to listen to a corded headphone:
 - You can connect up to 2 corded headphones to the base station.
 - Adjust the volume on the base station: this will have no effect on the headphone.
 - Adjust the bass as desired by pressing the DBE button on the base station: this will have no effect on the headphone.

Problem solving

If a fault occurs, first check the points listed below. If you are unable to remedy a problem by following these hints, contact the helpline (see 'Need help?') or consult your dealer.

Never try to open the set yourself as this will void the guarantee.

First, check all cables to ensure that they are connected correctly.

Problem	Solution
No sound	<ul style="list-style-type: none"> • Check if the mains cable is fully inserted into the AC outlet and that its connector is properly inserted into the AC input connector located at the rear of the base station. • Check if the audio source is switched on and tuned to a channel with audio. • In case of an audio source with adjustable output level: adjust the output level of the audio source to a higher and non-distorted level. • Volume on base station or headphone is set too low. Adjust the volume on the base station/headphone to a higher level. • The audio signal from your SACD player is upsampled. Lower the sampling rate through the SACD player's menu to 44.1 kHz • The audio signal from your DVD player is upsampled: lower the PCM sampling rate through the DVD player's menu to 48 kHz. • Invalid digital audio signal: the 'DIGITAL' indication LED in the HP1500 display window will be illuminated in red. Change the digital audio signal (for example: by changing from MP3 to audio CD) or switch to the analogue input signal of the HP1500 base station. • Check whether the audio output connector of your audio source is connected to the correct audio input connector of the HP1500 base station.
Distorted sound	<ul style="list-style-type: none"> • In case of an audio source with adjustable output level: adjust the output level of the audio source to a higher and non-distorted level. • Volume on base station or headphone is set too high. Adjust the volume on the base station/headphone to a lower level. • Check whether the output connector of your audio source is connected to the correct audio input connector of the HP1500 base station.

Maintenance

- If the headphone will not be used for a longer time, please remove the batteries to prevent leakage and corrosion.
- Hearing Safety! Continuous use at a high volume may permanently damage your hearing.
- Do not leave the headphone near heat sources. Do not expose to direct sunlight, excessive dust, moisture, rain or any kind of mechanical shock.
- Do not use alcohol, thinner or petroleum-based substances to clean the headphone or transmitter. Use a slightly dampened chamois cloth to clean the housing.
- Do not use cleaning agents containing alcohol, spirits, ammonia or abrasives as these may harm the housing.

Technical specifications*

Input sensitivity: 500 mVrms (1 kHz sine wave)

Power supply – base station: **SBC HP 1500/00 & /05**
230 VAC 50Hz

Signal/Noise ratio: 85 dB typical
(1 kHz sine wave, A-weighted)

HP 1000 Headphone

Distortion: 0.8% THP typical

Sensitivity: 106 dB

Frequency range: 40 – 40,000 Hz

Impedance: 32 Ohm

Headphone cable: 4.0 m (12 ft) LC OFC

Max. power input: 1500 mW

***) All specifications are subject to change without prior notice.**

Hereby, Philips Consumer Electronics, B.U. Peripherals & Accessories, declares that this digital headphone system (HP1500) is in compliance with the essential requirements and other relevant provisions of Directive 89/336/ECC.

European Regulations

This product has been designed, tested and manufactured according the European EMC directive 89/336/ECC.

The EMC equipment category class 2 has been used for compliance demonstration to these directives.

Following this Directive, this product can be brought into service in the following states:

SBC HP 1500/00

B	✓	DK	✓	E	✓	GR	✓	F	✓
IRL	✗	I	✓	L	✓	NL	✓	A	✓
P	✓	SU	✓	S	✓	UK	✗	N	✓
D	✓	CH	✓						

SBC HP 1500/05

B	✗	DK	✗	E	✗	GR	✗	F	✗
IRL	✓	I	✗	L	✗	NL	✗	A	✗
P	✗	SU	✗	S	✗	UK	✓	N	✗
D	✗	CH	✗						

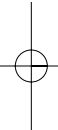
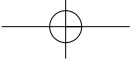

www.philips.com

This document is printed on chlorine free produced paper

Data subject to change without notice

Printed in China



PHILIPS

